





Portrait Operational Systems

- Cordless Systems
- Coded Systems (Standard Cordlock)
- Cordloop System (Chain Drive)
- Motorisation
- Smart Fit (for French Doors)
- Vertical Blinds

1. Terminology

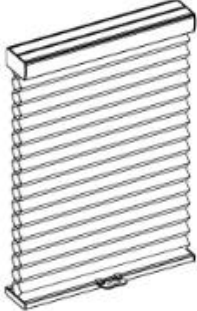
1.1 Cordless System

<p>25mm & 45mm SmartRise™ Cordless</p>	<p>25mm & 45mm Cordless TDBU</p>	<p>25mm & 45mm Cordless Day & Night</p>
		
<p>62mm SmartRise™ Cordless</p>	<p>62mm Cordless TDBU</p>	<p>62mm Cordless Day & Night</p>
		



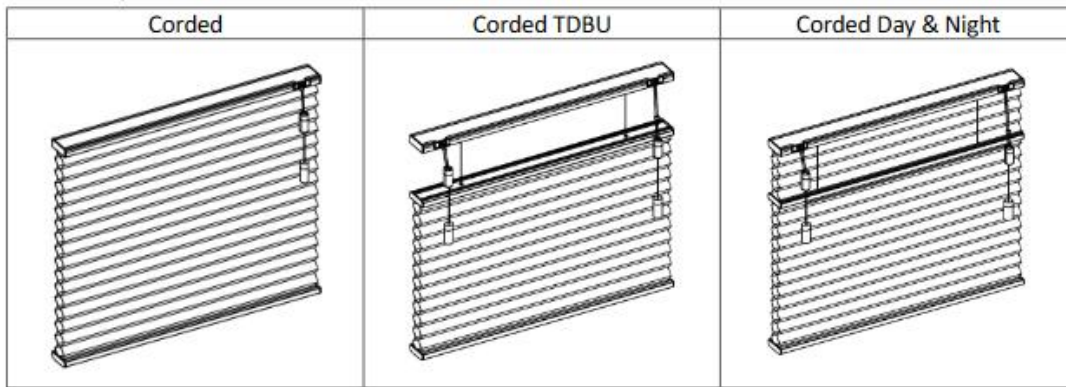

1.3 Corded System

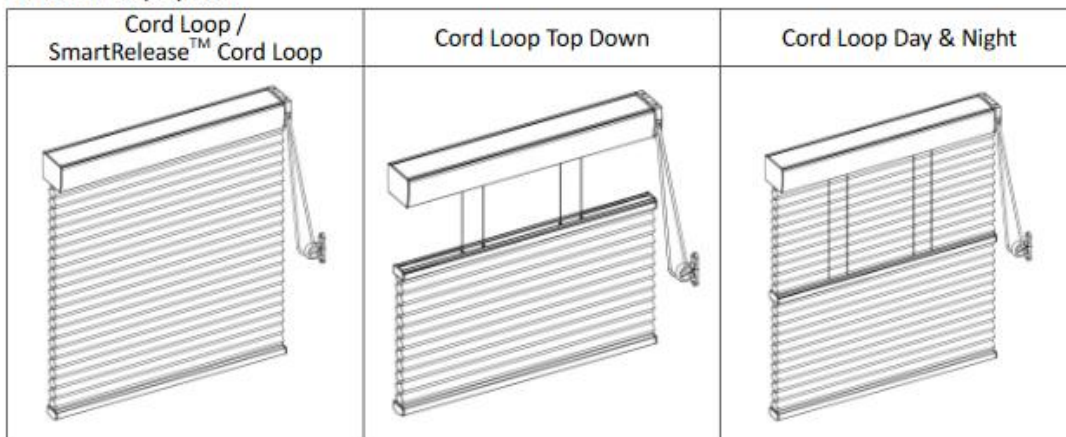

1.4 Cord Loop System

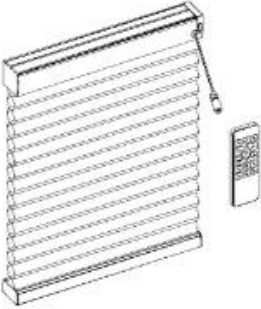

1.5 Motorisation

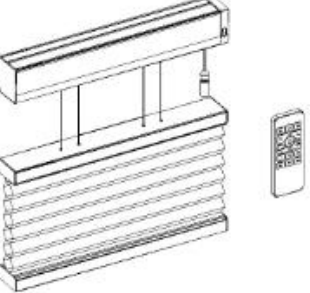
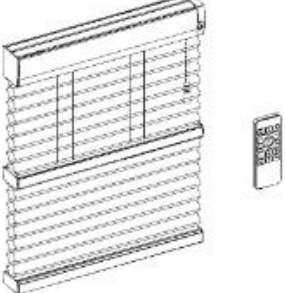
Motorisation with AC Power – DC Power Cord on the Front		
MCS Motorised Cordless (Regular)	DMCS Motorised Top Down Bottom Up	DMCS Motorised Day & Night
		
Motorisation with AC Power – DC Power Cord on the Back		
MCS Motorised Cordless (Regular)	DMCS Motorised Top Down Bottom Up	DMCS Motorised Day & Night
		

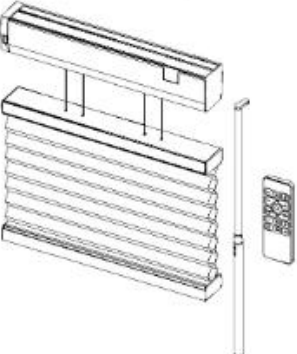
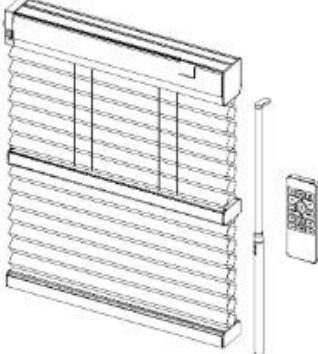
Motorisation with Battery Power		
MCS Motorised Cordless (Regular)	DMCS Motorised Top Down Bottom Up	DMCS Motorised Day & Night
		

Disclaimer: Norman reserves all rights on updating or modification of any contents within this documentation without prior notification.

1.6 SmartFit Bottom Up (Mounting angle: 0° ~15°)

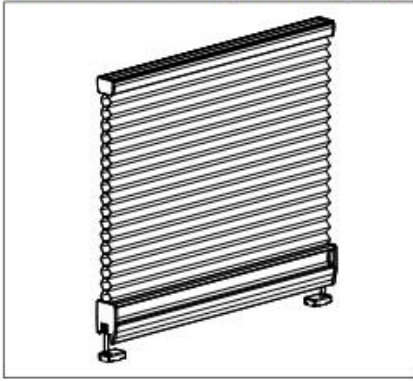





1.7 SmartFit™ System (Mounting angle: 0° ~15°)

SmartFit™ with Aluminum Preinstalled Top Rail		
25mm Single		45mm Single/ Double & 62mm Single/ Double
Model A For width $x \leq 1270\text{mm}$	Model B For width $x > 1270\text{mm}$	

SmartFit™ without Aluminum Preinstalled Top Rail			
25mm Single		45mm Single/ Double & 62mm Single/ Double	
Model A For width $\leq 1270\text{mm}$	Model B For width $> 1270\text{mm}$	When inside mount and shade width $> 1016\text{mm}$, there is a 2mm gap between the headrail and the window opening.	

1.8 SmartFit™ Day & Night (Mounting angle: 0° ~15°)

SmartFit™ Day &Night with Aluminum Preinstalled Top Rail	
25mm Single Model A Only For Width \leq 1270mm	45mm Single/ Double & 62mm Single/ Double
	
SmartFit™ Day &Night without Aluminum Preinstalled Top Rail	
25mm Single Model A Only For Width \leq 1270mm	45mm Single/ Double & 62mm Single/ Double
	

1.9 SmartFit™ for Sloped Windows(Mounting angle: 45° ~90°)

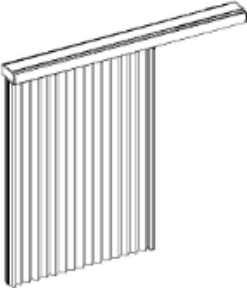
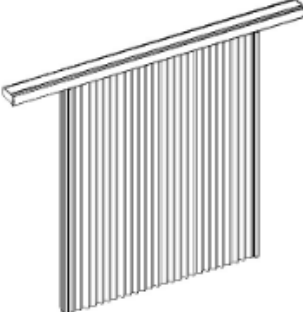
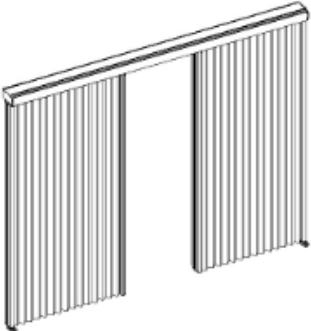
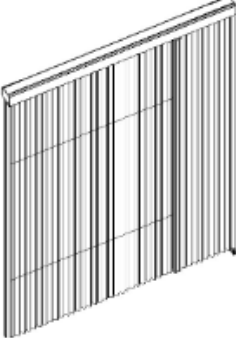
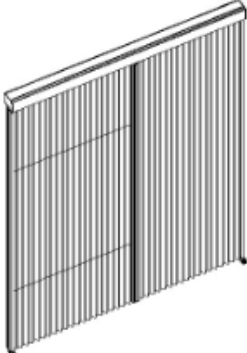
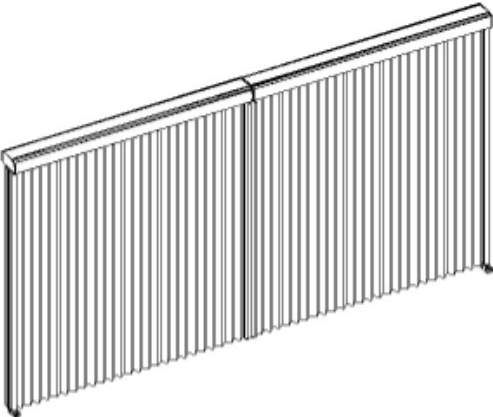
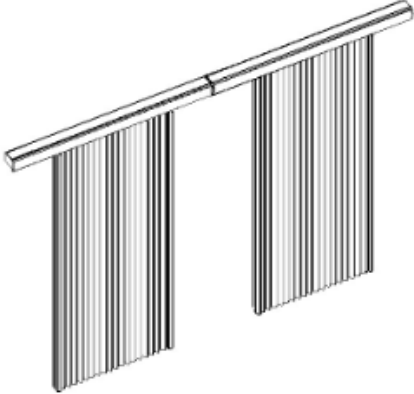

2.1 Patio Door Vertical System

Right Stack	Left Stack	Travelling Centre Stack
		
Split Stack (Centre Opening)	Uneven Width	Patio Door Vertical Day & Night
		
<p>Left Stack + Right Stack side by side. Thicker magnetic strips are added on moving rails in the centre to allow the two shades to join together</p>		<p>Travelling Centre Stack + Travelling Centre Stack, side by side. Thicker magnetic strips are added on moving rails in the centre to allow the two shades to join together</p>
		

Disclaimer: Norman reserves all rights on updating or modification of any contents within this documentation without prior notification.